

### RRX Rigid PVC Wiring Ducts

RR Extrusions manufactures slotted cable trunking also known as wiring ducts, as a part of cable management solutions. Our PVC wiring ducts help to protect and route cables within control panels and switchgear systems, making your and your direct customers business more efficient.

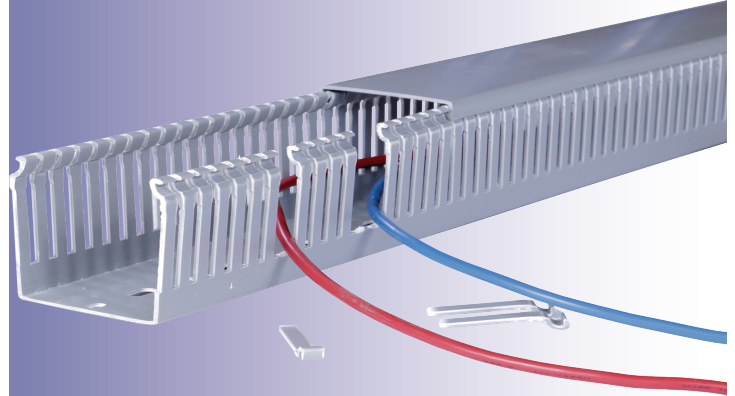

RR Extrusions's RRX series rigid PVC wiring ducts

### Benefits and Features

- Manufactured from specially compounded high-impact rigid PVC ( polyvinyl chloride)
- Pre-notch snap-off points enable fingers to be removed effortlessly.
- Self-extinguishing and warp-proof.
- Highly tensile and good compressive strength, hence the wiring ducts do not peel, chip or crack.
- Unique locking design provides easy mounting and removal of duct covers, and prevents popping of wires.
- Elongated slots and punched holes on the base as per DIN EN 50085-2-3 standards.
- Secure duct covers that are well-fixed even in vertical positions.

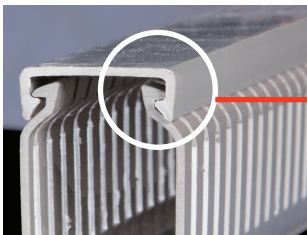

#### Secure Lid/Duct Covers

\*We provide individual lid purchases for all sizes

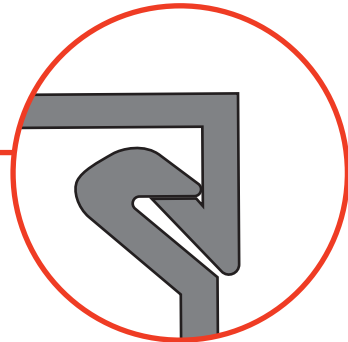

### Product Properties

Properties	
<b>Mechanical</b>	
Colour	Grey
Length	2 m
Tensile Strength	390kg/cm <sup>2</sup>
<b>Electrical</b>	
Dielectric Strength	36 kV/mm
Specific resistance	6.1 x 10 <sup>14</sup> Ω-m
<b>Thermal</b>	
Flammability	UL 94 VO

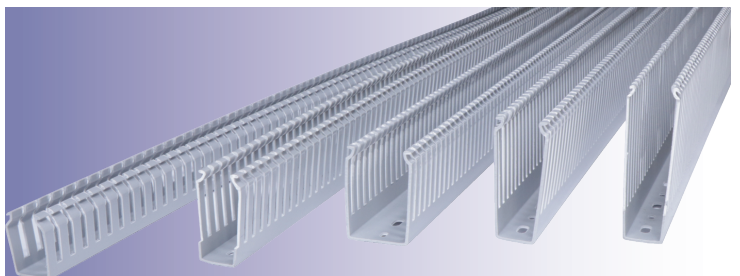

\*Other colours such as black, ivory and white are available on request. Blue and green colors are available for bulk orders.

\*Halogen free and RoHs compliant materials are available on request.

## Technical data - Slot/Hole Pattern

Product-No.	Size (WxH)	A	B	C	D	E
RRX2525	25 x 25	-	-	12.5	6.5 x 14.5	4.5 x 8
RRX2540	25x40	-	-	12.5	6.5 x 14.5	4.5 x 8
RRX2560	25x60	-	-	12.5	6.5 x 14.5	4.5 x 8
RRX2580	25x80	-	-	12.5	6.5 x 14.5	4.5 x 8
RRX25100	25x100	-	-	12.5	6.5 x 14.5	4.5 x 8
RRX4040	40x40	-	-	20	6.5 x 14.5	4.5 x 8
RRX4060	40x60	-	-	20	6.5 x 14.5	4.5 x 8
RRX4080	40x80	-	-	20	6.5 x 14.5	4.5 x 8
RRX40100	40x100	-	-	20	6.5 x 14.5	4.5 x 8
RRX6060	60x60	-	-	30	6.5 x 14.5	4.5 x 8
RRX6080	60x80	-	-	30	6.5 x 14.5	4.5 x 8
RRX60100	60x100	-	-	30	6.5 x 14.5	4.5 x 8
RRX8060	80x60	50	15	-	6.5 x 14.5	4.5 x 8
RRX8080	80x80	50	15	-	6.5 x 14.5	4.5 x 8
RRX80100	80x100	50	15	-	6.5 x 14.5	4.5 x 8
RRX100100	100x100	50	25	-	6.5 x 14.5	4.5 x 8

\*All dimensions in mm. Subject to technical changes.

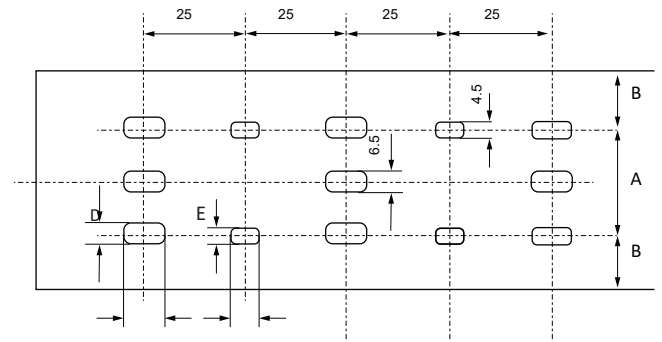

Sizes : 80x60, 80x80, 80x100, 100x100,

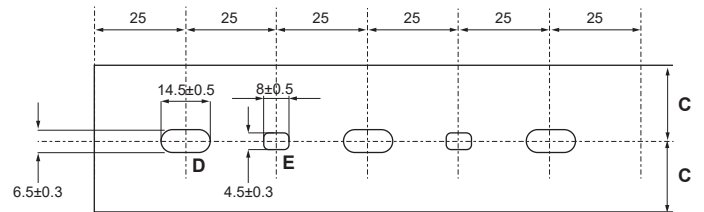

Sizes: 25x25, 25x40, 25x60, 25x80, 25x100, 40x40, 40x60, 40x80, 40x100, 60x60, 60x80, 60x100

## Technical data - Dimension

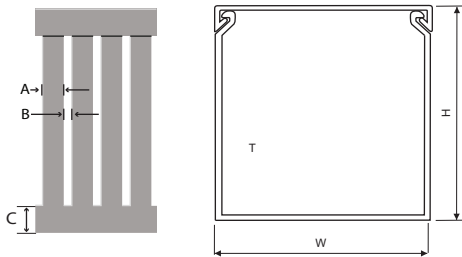

RRE Extrusions-RRX wiring ducts

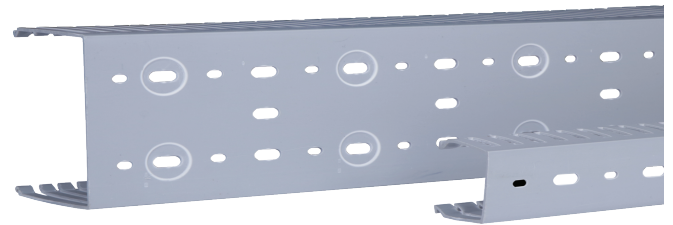

Slot/ hole pattern and base perforation based on DIN standards

Product-No.	Width (W)	Height (H)	Thickness (T)	A	B	C	Packing Content (units/carton)
RRX2525	25	25	1.2	6	4	10	50
RRX2540	25	40	1.5	7.5	5	8	40
RRX2560	25	60	1.5	6	4	12	28
RRX2580	25	80	1.5	6	4	18	20
RRX25100	25	100	1.6	6	4	18	28
RRX4040	40	40	1.5	7.5	5	8	24
RRX4060	40	60	1.5	6	4	12	28
RRX4080	40	80	1.6	6	4	15	20
RRX40100	40	100	1.6	6	4	18	16
RRX6060	60	60	1.6	6	4	12	24
RRX6080	60	80	1.8	6	4	15	18
RRX60100	60	100	1.8/1.9	6	4	18	12
RRX8060	80	60	1.8	6	4	15	18
RRX8080	80	80	1.8	6	4	18	12
RRX80100	80	100	2.0	6	4	12	8
RRX100100	100	100	2.0	6	4	18	8

\*All dimensions in mm. Subject to technical changes.

### Cable housing capacity

Product-No.	Size (WxH)		Maximum No. of Cables accomodated		
	mm	Inch	1.5 mm <sup>2</sup> (AWG# 16)	2.5 mm <sup>2</sup> (AWG# 14)	4.0mm <sup>2</sup> (AWG# 12)
			OD 3.18mm	OD 3.53mm	OD 4.01mm
RRX2525	25 x 25	0.98 x 0.98	19	15	12
RRX2540	25x40	0.98 x 1.57	48	35	24
RRX2560	25x60	0.98 x 2.36	72	55	40
RRX2580	25x80	0.98 x 3.15	96	75	54
RRX25100	25x100	0.98 x 3.94	138	95	70
RRX4040	40x40	1.57 x 1.57	80	72	48
RRX4060	40x60	1.57 x 2.36	130	108	70
RRX4080	40x80	1.57 x 3.15	180	153	91
RRX40100	40x100	1.57 x 3.94	230	198	126
RRX6060	60x60	2.36 x 2.36	195	168	110
RRX6080	60x80	2.36 x 3.15	270	224	154
RRX60100	60x100	2.36 x 3.94	345	234	198
RRX8060	80x60	3.15 x 3.15	360	288	210
RRX8080	80x80	3.15 x 3.94	450	378	255
RRX80100	80x100	3.15 x 2.36	270	224	154
RRX100100	100x100	3.94 x 3.94	600	462	342

\*OD stands for outer diameter of the cable

### About us

RR extrusions FZ LLC is an independent and professional manufacturer based out of UAE, with a technical experience of producing quality **PVC products**. We possess a leading edge extrusion technique and a high standard industrial facility enabling us to produce PVC products that can best-serve our customer's requirement and needs.

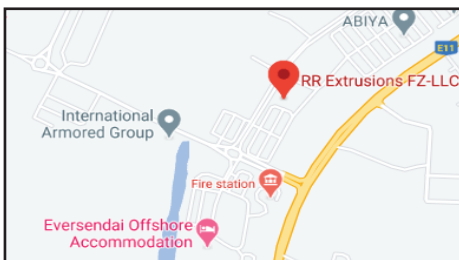

Our initial development and manufacturing services include the production of slotted **cable trunking systems** as a part of our **cable management** solutions for cabinets and equipment.

We provide **OEM** and **ODM** manufacturing services catering to your market specific requirements. Our production process produces quality products with finesse which will help your company increase its brand value, and help you serve your customers better.



Location on Google Maps

### Get in touch!

-  [www.rrextrusions.com](http://www.rrextrusions.com)
-  [rrextrusions@gmail.com](mailto:rrextrusions@gmail.com)
-  +971 50 430 9767 / +971 55 823 6491

**RR Extrusions FZ-LLC**  
 1-038, Ras Al Khaimah Economic Zone  
 RAKEZ Industrial Park, Ras Al Khaimah  
 UAE. PO Box : 50010